

Evolutional Conjunction Table System

ASISTA is a table sufficiently equipped with necessary functions, such as large wiring space & desktop panel. With variation of single sided and double sided type, supporting with different kinds of connection, it demonstrates its superior scalability. From work scene to meeting scene, a simple table system supports different kinds of scene, that is ASISTA.

WIRING SYSTEM

Wiring Cover



Easy access wiring cover
Adopt rectangular flip top with brush strips. It is an easy- to use structure for opening & closing.

Wiring Space



Equipped with large wiring space
Enough space for wiring and smooth access and easy action thanks to removable wiring cover.

Shared Leg



Shared Leg for Vertical Wiring
The shared leg has enough space for vertical wiring to make best use of large wiring tray.

PLATFORM

D600(1200)mm TYPE

- With space-saving design, this type can cope with limited space.

D700(1400)mmTYPE

- This type can ensure enough space for general office design.

Double-sided Basic Platform

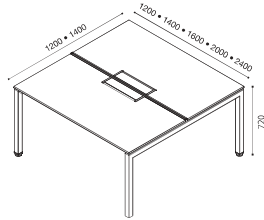

D1200mm		D1400mm	
Wmm	Cat. No.	Wmm	Cat. No.
1200	5-177-101	1200	5-177-111
1400	5-177-102	1400	5-177-112
1600	5-177-103	1600	5-177-113
2000	5-177-105	2000	5-177-115
2400	5-177-106	2400	5-177-116

Single-sided Basic Platform

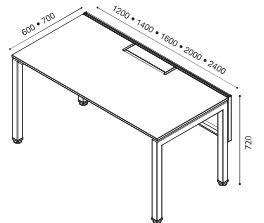

D600mm		D700mm	
Wmm	Cat. No.	Wmm	Cat. No.
1200	5-177-151	1200	5-177-161
1400	5-177-152	1400	5-177-162
1600	5-177-153	1600	5-177-163
2000	5-177-155	2000	5-177-165
2400	5-177-156	2400	5-177-166

Main Body Specification

Table Top : Low Presser melamine, particle board
 Thickness of Table Top : 18mm
 Table leg : Steel, white Paint

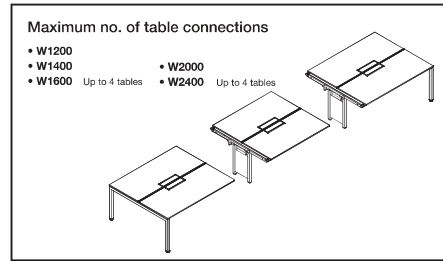

Double-sided Connection Platform

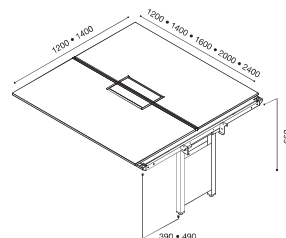

D1200mm		D1400mm	
Wmm	Cat. No.	Wmm	Cat. No.
1200	5-177-121	1200	5-177-131
1400	5-177-122	1400	5-177-132
1600	5-177-123	1600	5-177-133
2000	5-177-125	2000	5-177-135
2400	5-177-126	2400	5-177-136

Single-sided Connection Platform

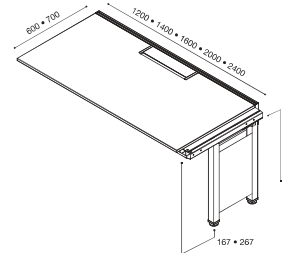

D600mm		D700mm	
Wmm	Cat. No.	Wmm	Cat. No.
1200	5-177-171	1200	5-177-181
1400	5-177-172	1400	5-177-182
1600	5-177-173	1600	5-177-183
2000	5-177-175	2000	5-177-185
2400	5-177-176	2400	5-177-186

Color of Table Top :



M-White = 1 MK-Maple = 2 Grey = 3 Lindau = 4
 Assign the □ number to choose table top color.

DESKTOP PANEL

Front Desktop Panel

H350mm (Fabric)
Wmm
1200
1400
1600
2000
2400

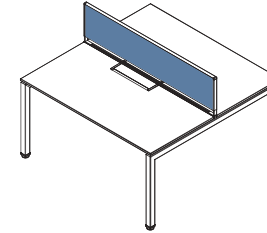

H450mm (Fabric)
Wmm
1200
1400
1600
2000
2400

Side Desktop Panel (End/Middle)

H350mm (Fabric)
Wmm
600
700

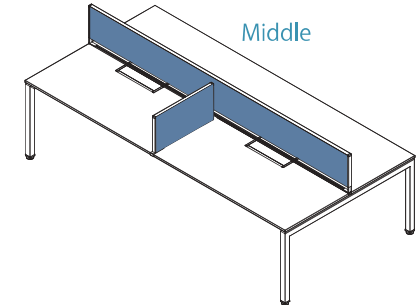
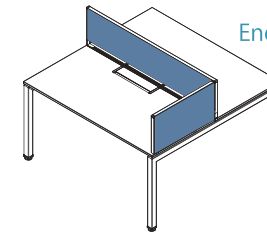

H450mm (Fabric)
Wmm
600
700

□ : Panel fabric color no.
 * For the details (price & cat. no.), please refer to the price list.

Panel Fabric Colors

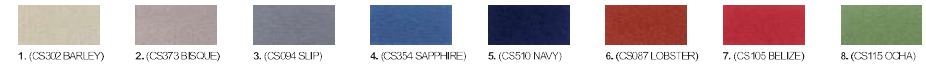

OPTION



SIDE MODESTY PANEL

Wmm	Cat. No.
600	5-177-6600
700	5-177-6610
1200	5-177-6620
1400	5-177-6630

1 pcs with 1 unit